



Natural Woven Shade Installation Guide



Before starting

Your new Blinds To Go® natural woven shade is custom made to your specifications from the finest material available. The installation should be easy and your shade should fit beautifully.

Mounting Options

Inside mount: Shade is mounted inside the window frame at the top, or into the ceiling.

Outside mount: Shade is mounted either on or above the window frame.

Side mount: Shade is mounted to the two sides of the window frame. This option reduces the visibility of the brackets from outside of the house, while increasing it from within.

Parts

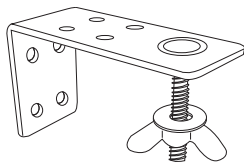

Mounting brackets
Quantity: 2 or more depending
on width of blind



Screws
Quantity: 2 per bracket

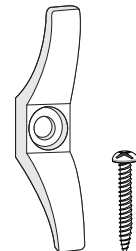

Cord cleat and screws
Quantity: 1

Optional Hardware *(only provided for specific applications)*

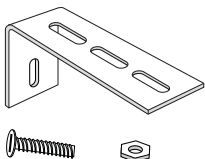

Side mount/
extension brackets
Quantity: 2

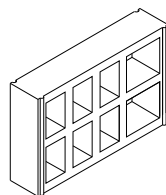

Spacer Blocks
Quantity:
1 for each bracket

Note: Mounting screws provided are suitable for most mounting surfaces. See below for additional suggestions.

For wallboard or plaster: Use hollow wall anchors for added support.

For concrete, stone, brick or tile: Use an appropriate drill bit and appropriate anchors before fastening the screws.

For metal surfaces: Pre-drill holes before fastening the screws.

Suggested Tools

- Drill
- Level
- Pencil
- Screwdriver
- Tape measure

Getting started

Step 1. Mounting brackets

1. Hold the shade to where you want to mount it and mark the position of the brackets.

inside and outside mount

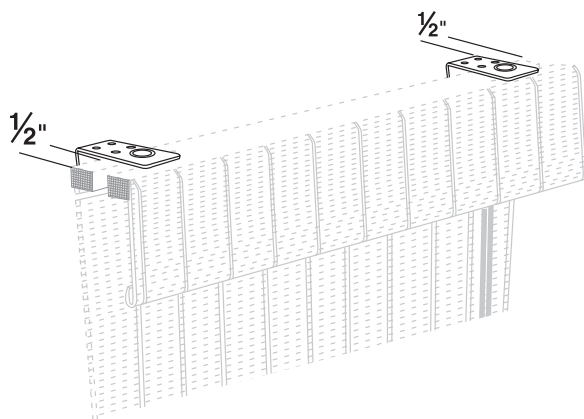

side mount

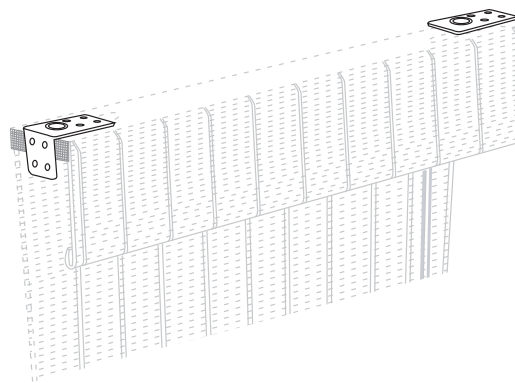

Note: When more than two brackets are provided, mount the additional brackets so the bolt will go through the center of the additional mounting slots. Make sure all the brackets are aligned.

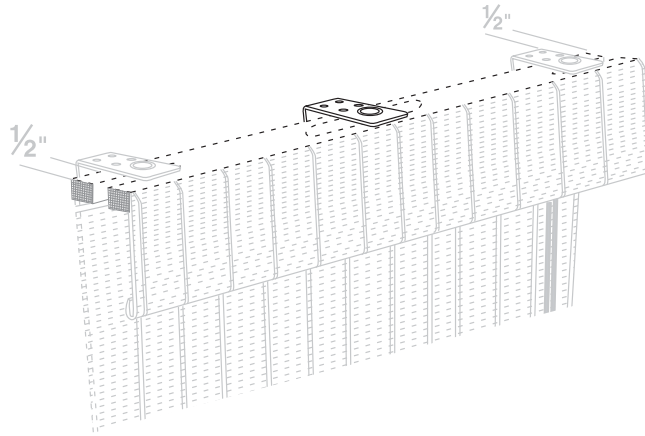

2. Before mounting the brackets, make sure the mounting surface is level. Apply shim if necessary. Then mount the brackets as illustrated.

inside mount

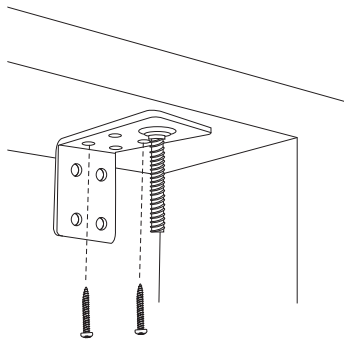

outside mount

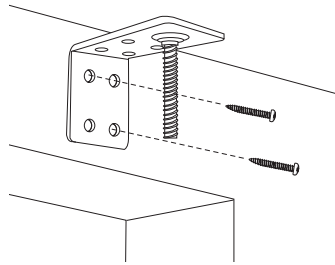

side mount

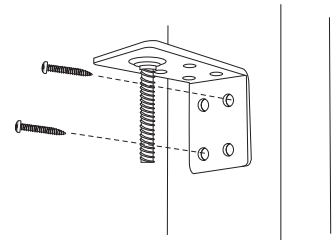

Step 2. Fitting the shade into the brackets

Fit the shade up into the brackets so that the bolts come through the mounting slots on each end of the headrail. Then place washer and wing nut on bolt and tighten securely.

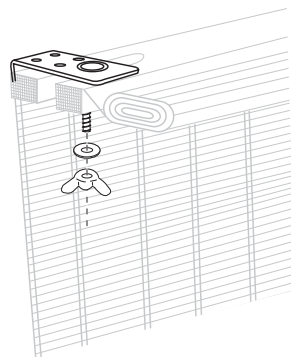

applying spacer blocks (optional)

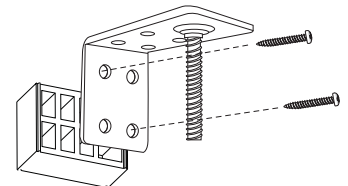

For 2 or 3 on 1 shades:
If you have ordered a shade with 2 or 3 shades on the same headrail, it is particularly important to ensure that all the brackets are secured with the same level of tension so that the headrail stays straight and the gap between the shades is even.

Step 3. Mounting the cord cleat *(for child safety)*

This cleat is to be used when there is excessive cord dangling, especially when the shade is in the raised position. This helps reduce the risk of a child playing with loose cords.

1. Mount the cleat out of reach of children. Exact location of the cord cleat is not critical, it can be mounted inside the frame, on the frame or outside the frame.
2. Wrap the excess cord around the cleat as illustrated.



Operating your shade

1. To lower or raise the shade, pull the cord toward the center of the shade to unlock the cord lock.
2. While holding the cord toward the center of the shade, raise or lower the shade until it reaches the desired height.
3. Then move the cord away from the center of the shade, beyond the outside edge of the shade, to lock the shade in position.

