



Installation Guide



A  PRODUCT

Components:

1*-Battery Pack

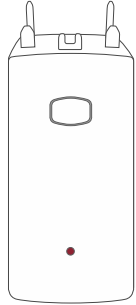

2*- Solar Panel

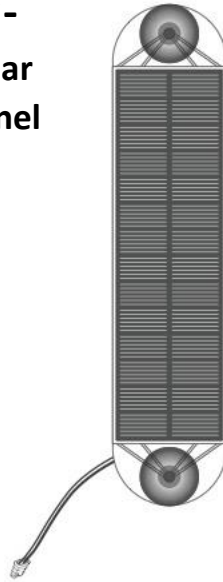

3*-Power Supply

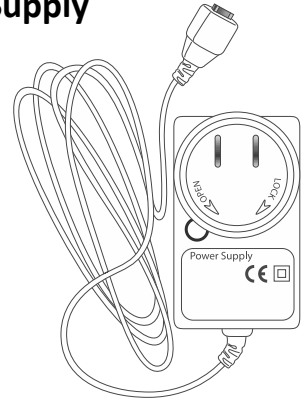

4- Mounting Plate

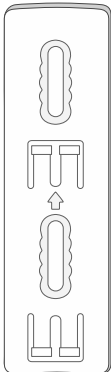

6- anchors

5- Screws

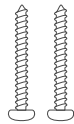

7-Metal Connector



8- MOVE Unit

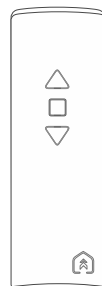
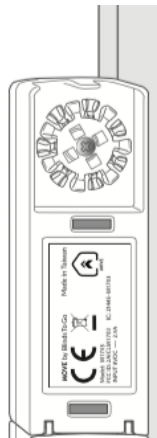

***NOT SOLD WITH EVERY UNIT**

1. Prepare your shade:

WHAT YOU WILL NEED:



- a) . Remove all components on beaded chain such as connectors, stoppers, & tension devices shown below-Please refer to your manufacturers guide on how to remove
- b) Replace existing connector with provided metal connector.

Image A

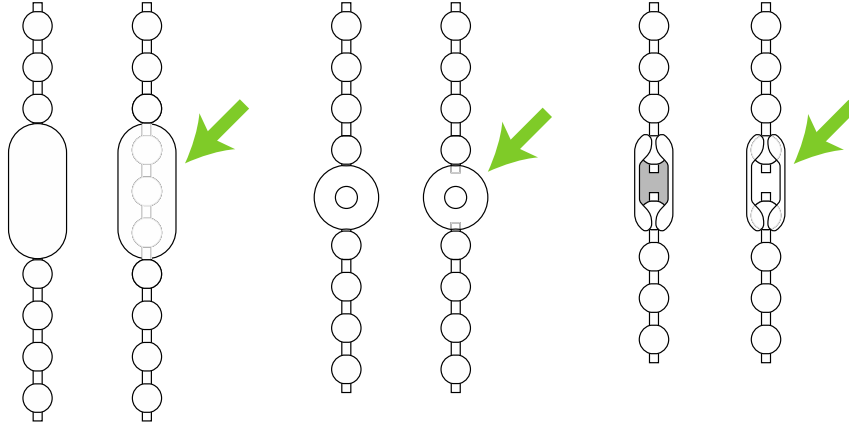

2. Determine Your Mount Position: (3 Options)

- a) Inside Mount (Image A)– Make sure nothing will interfere with the operation of the shade. You must have minimum of 2” in front of shade
- b) Outside Mount (Frame or Wall) (Image B) – flat on frame or wall facing the room

IMAGE A

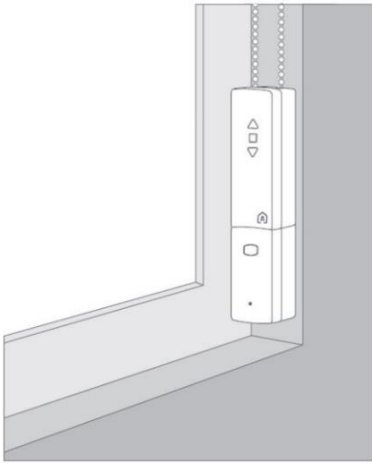
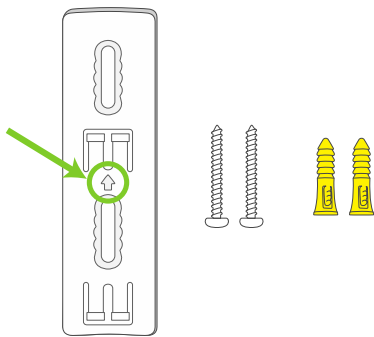

IMAGE B



3. Installing Mounting Plate:

What you will need:



-
- a) Using the beaded chain as a guide, align the mounting plate (arrow must be point up) to where the chain is fully tensioned as shown in image A

- b) Mark holes for screws at the bottom of screw channels as shown in image B
- c) Making sure the mounting plate is straight and flat use a screw driver or power drill (not included) to install the screws and anchors into the mounting plate as shown in image C

IMAGE A

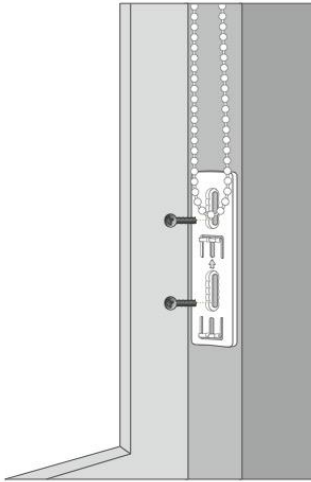

IMAGE B

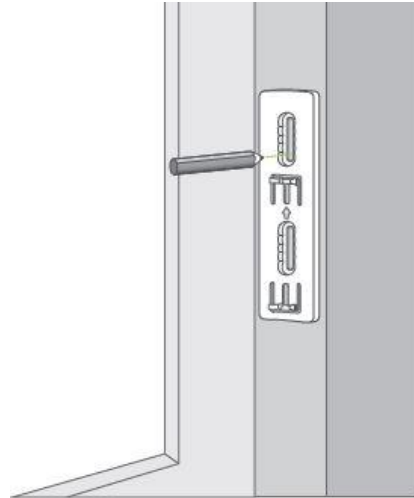
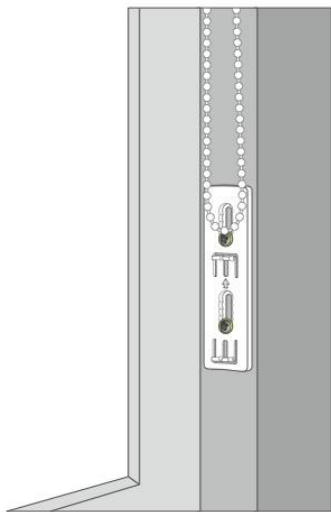
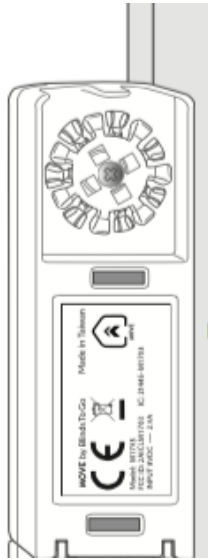

IMAGE C



4. Attaching Unit

What you will need:



IF APPLICABLE

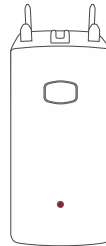

- a) Attach beaded chain into MOVE unit along the grooves on the spool (Image A)-
- b) Make sure beaded chain is not twisted and attach the MOVE unit into the mounting plate sideways.(image B) (If you have rechargeable battery (see component 1) you must attach it to the MOVE unit before attaching to mounting plate)

Please Note: If chain is not tensioned remove unit by peeling off sideways, loosen screws in mounting plate & reposition

IMAGE A

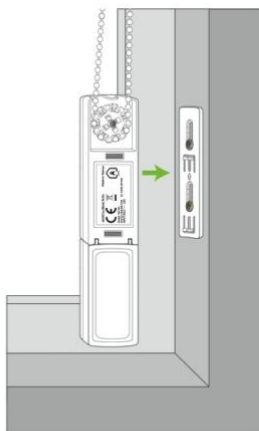
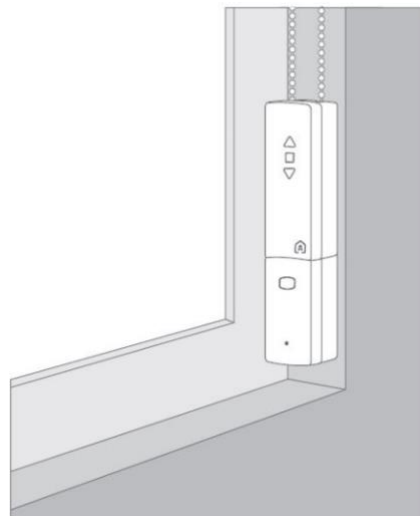

IMAGE B



5. Power Options

a) Rechargeable battery pack with power supply

WHAT YOU WILL NEED:

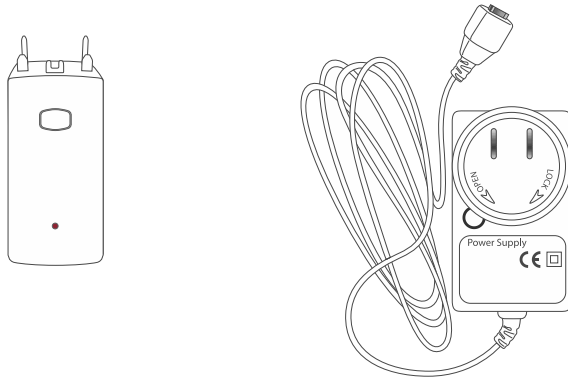

- I. Plug the micro USB on the power adapter into the unit and the opposite end into an outlet and let charge until red light turns off (approx. 6 hours). Once the battery is fully charged remove the power adapter from the battery and store for future use.

*NOTE: Battery comes with 20% charge

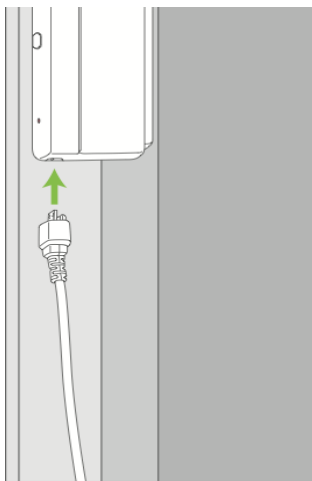

Please Note: Red light will flash on battery pack (indicated below) every 30 seconds when low battery is detected

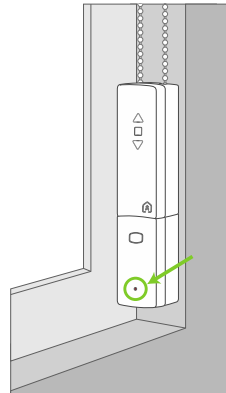

b) Rechargeable battery pack with Solar Panel

WHAT YOU WILL NEED:

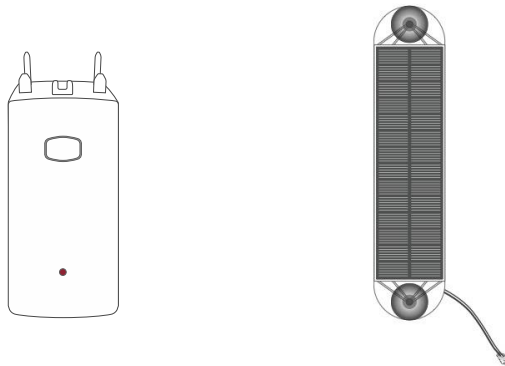

- i. Connect Solar Panel to window with solar panel facing window as shown below
- ii. Plug solar panel's micro USB into Rechargeable battery pack

Before

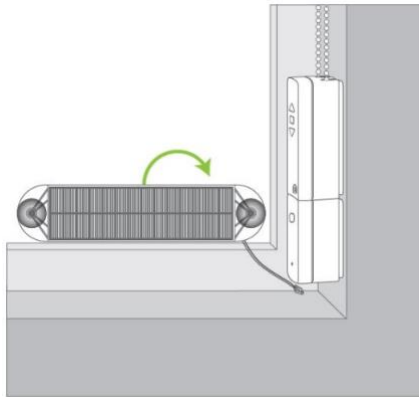

After

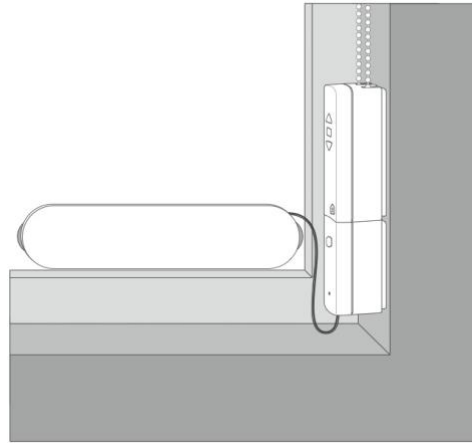

c) Direct power supply.
WHAT YOU WILL NEED:

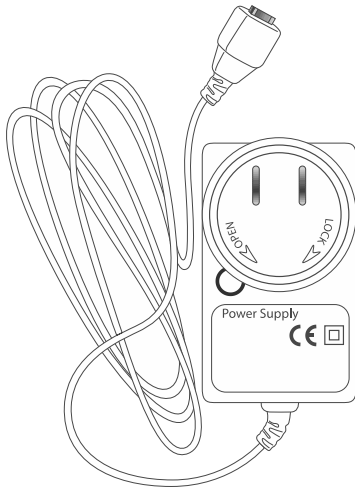

- I. Plug micro USB charger into MOVE unit as shown below
- II. Plug opposite end into outlet (power adapter must be plugged in at all times to allow MOVE unit to operate)

BEFORE

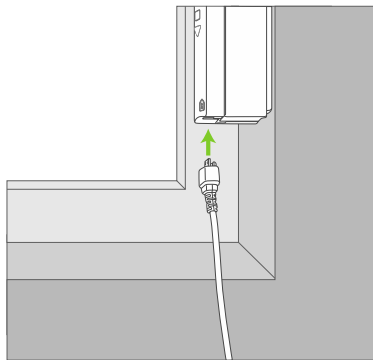

AFTER

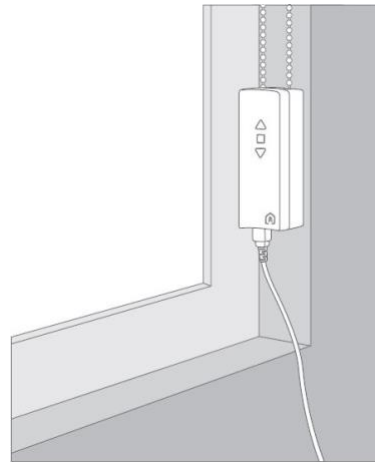

6. Download the App

- a. Download Move App by searching MOVE motorize blinds and shades from appropriate App store for your phone and follow the instructions to set up the Move Unit

ICON

